

Foldesystem for origamipengeseddel – allmenn fortolkning

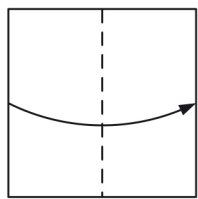

Dalfold

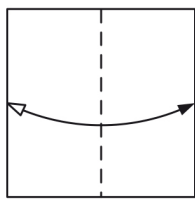
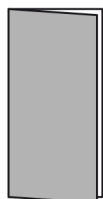

Dalfold, og fold ut igjen

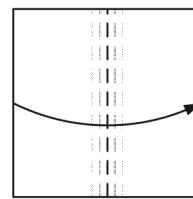
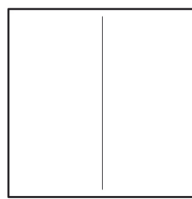

Variabel dalfold (T-up2you)

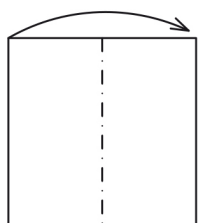

Bergfold

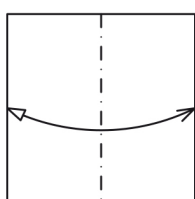

Bergfold, og fold ut igjen

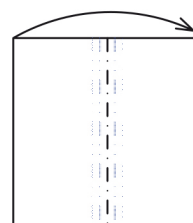
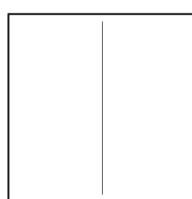

Variabel bergfold (M-up2you)

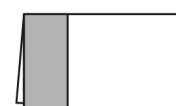
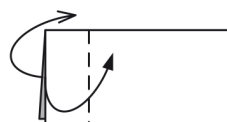
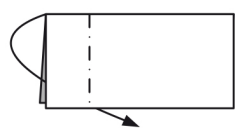
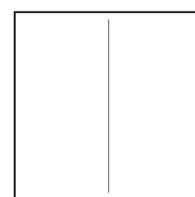
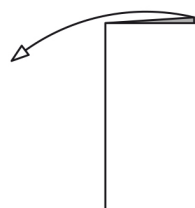
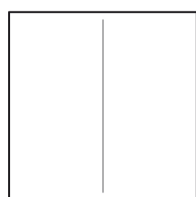
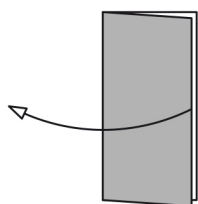

Fold ut igjen

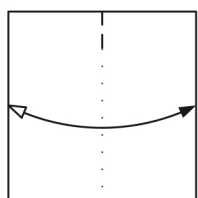

Markeringslinje

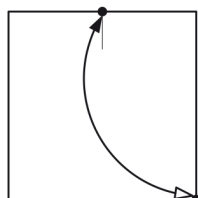

Markeringspunkter

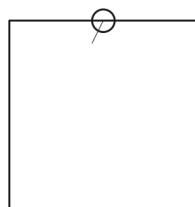

Hvisnings sirkel

08-09

Gjenta foldetrinn med det angitte nummer

Vend papiret

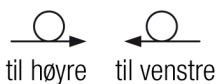

Roter papiret den angitte vinkel



Foldesystem for origamipengseseddel – CEWE-skjorte

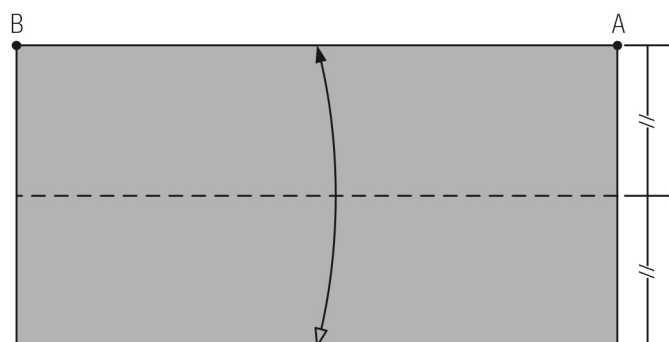

1. Dalfold nedre kant til øvre kant, og fold pengeseddelen ut igjen.

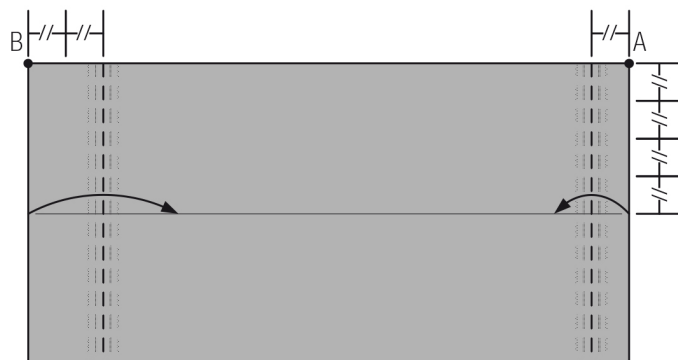

2. Dalfold venstre og høyre kant fremad, så høyre kant er halvparten så stor som venstre kant.

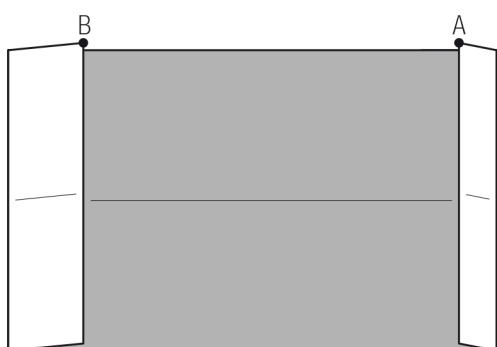

3. Vend pengeseddelen.

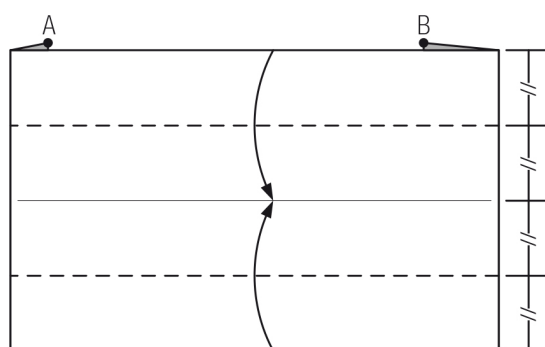

4. Dalfold nå øvre og nedre kant til midten.

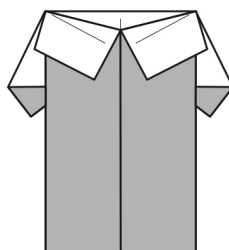
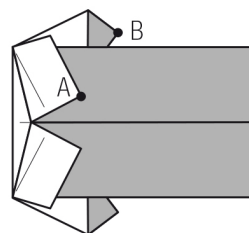
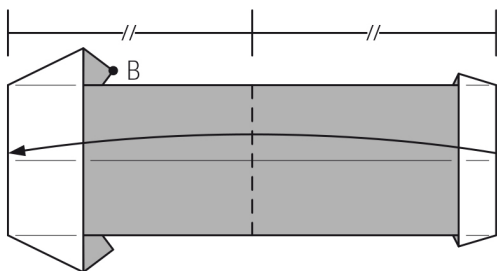
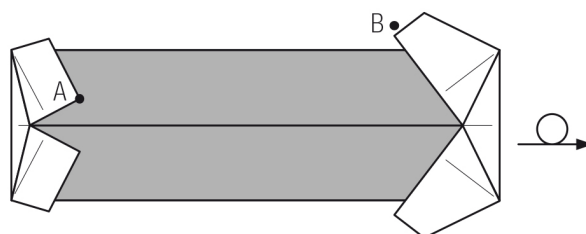

FERDIG!

Foldesystem for origamipengeseddel – CEWE-kjole

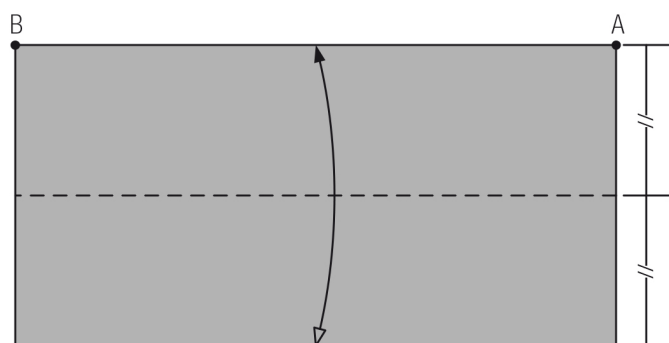

1. Dalfold nedre kant og fold pengeseddelen ut igjen.

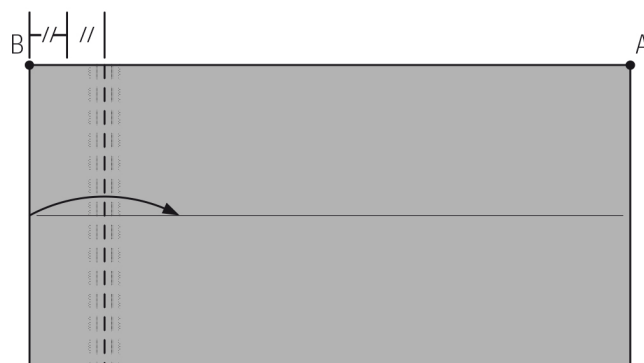

2. Dalfold venstre kant fremover. Fold pengeseddelen ut igjen.



3. Vend pengeseddelen.

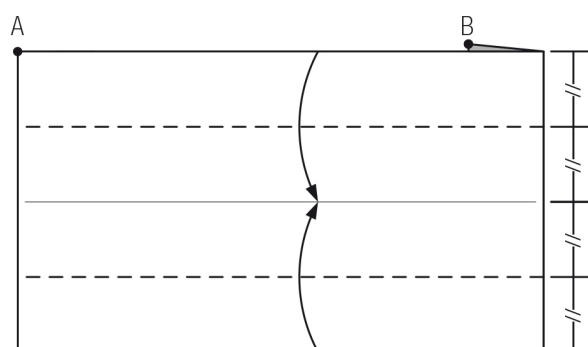

4. Dalfold nå nedre og øvre kant til midten.

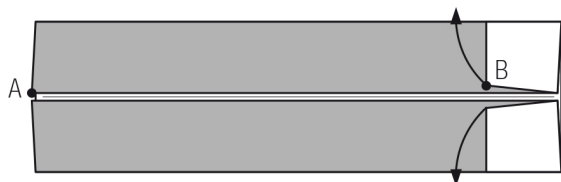

5. Trekk nå lett de to høyre hjørner i retning pilene, og trykk pengeseddelen flat.

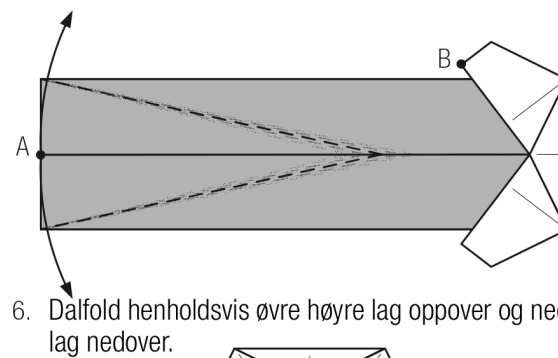
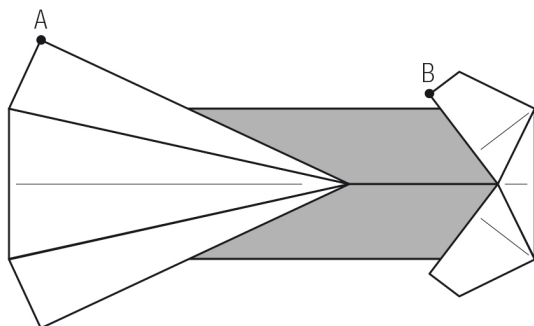

6. Dalfold henholdsvis øvre høyre lag oppover og nedre høyre lag nedover.

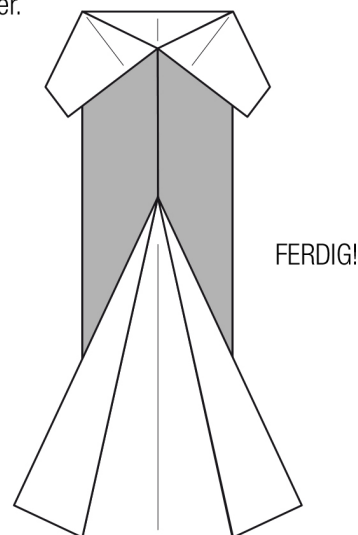

Foldesystem for origamipengeseddel – CEWE-hjerte

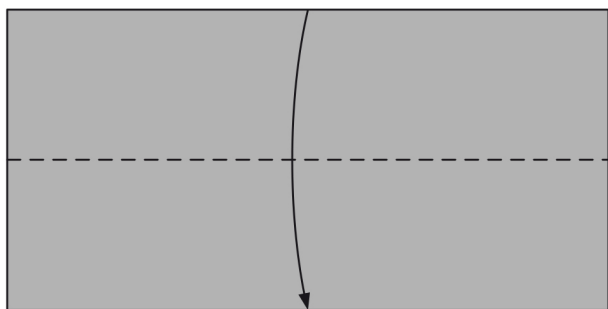

1. Dalfold øvre kant til nedre kant.



2. Dalfold høyre kant til venstre kant

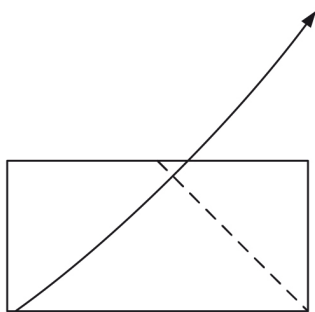

3. Dalfold pengeseddelen øvre lag oppover, så nedre kant rører ved høyre kant.

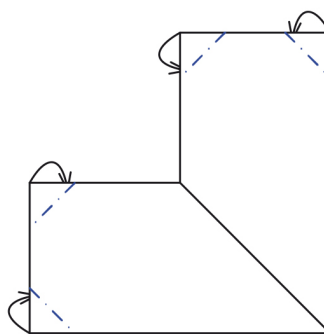

4. Bergfold de fire hjørnene bakover.

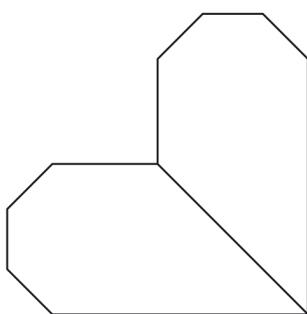

5. Vend hjertet.

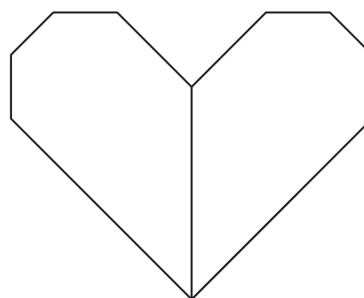

FERDIG!